

moveXX

driven by brain power



DATASHEET
Movexx T2500-SCOOTER
2018



Specifications T2500-SCOOTER

Frame	Steel, powder coated
Drive	24V DC, 800W, 170 rpm
Weight	300 kg
Weight trailer	2500 kg
Battery	Built in, 24V, 75Ah
Speed	Max. 8,0 km/h
Drive wheels	Full rubber $\varnothing 250 \times 80$ mm
Width	511mm
Length	1237mm
Adze height	1075mm
Folded	N/A
Noise level	68,5 dB
To use from	-40 °C / 70 °C
Protection class	Machine IP44

Dimensions T2500-SCOOTER

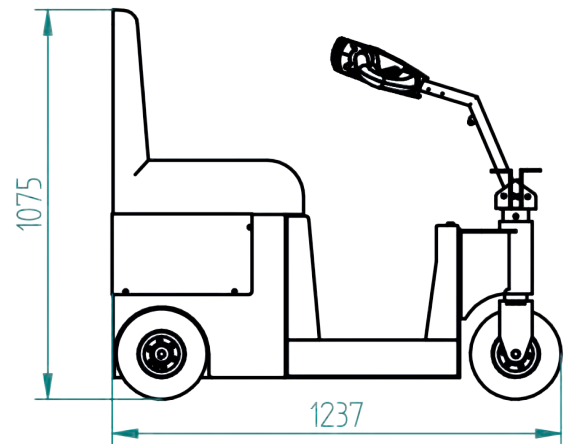
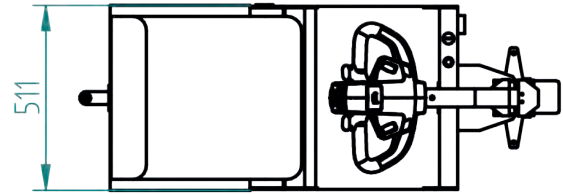

Pulling power T2500-SCOOTER (in kg)

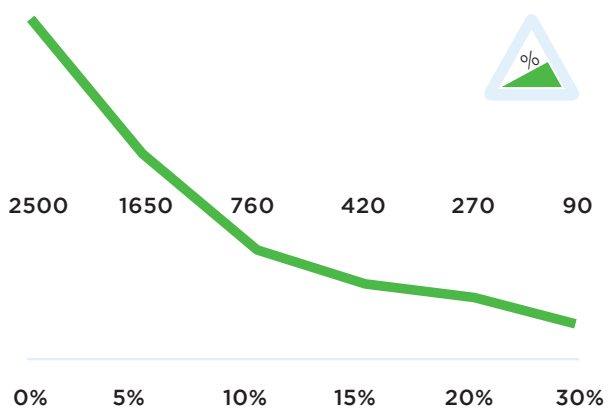

**Measured with a trolley with 2 swivelwheels and 2 fixed castors. Wheel diameter: 160mm*

Standard T2500-SCOOTER



Standard parts T2500-SCOOTER

Battery charger 24V 10A
AGM external ind



Item number:
M2134

Full-rubber drive wheel,
black Ø250mm



Dimensions Ø250 x 80 mm

Item number:
M0248

Adjustable tillerhead



Item number:
Standardpart 1

2 programmable speeds



Item number:
Standardpart 3

Standard parts T2500-SCOOTER

Motor 750W 140RPM
BRAKE 6911463X



Item number:
M2515

Battery 12V-80A



Item number:
M2102

Options T2500-SCOOTER



Upgrade Nonmarking
tires (3) yellow CR

Article number:
OPT0356



Upgrade Nonmarking
tires (3) grey

Article number:
OPT0358



Horn 103 dB

Article number:
OPT0059



Emergency stop complete

Article number:
OPT0063



Strobelight

Article number:
OPT0065



Safety fender for steering
wheel

Wheel Shield

Article number:
OPT0079



Strobelight on pole T2500

Article number:
OPT0119



Blue Safety spot

Article number:
OPT0251



Acoustic signal driving
backwards

Article number:
OPT0254



hour counter complete

Article number:
OPT0056



Horn 90dB

Article number:
OPT0057



Antistatic strip

Article number:
OPT0058

Options T2500-SCOOTER



Code lock

Article number:
OPT0068



Front bumper T2500-Platform+Scooter

Article number:
OPT0125



Preparation electric hook

Article number:
OPT0143



Ignition key unequal key

Article number:
OPT0145



Ignition key equal key 701

Article number:
OPT0146



Customized programming

please indicate specific settings

Article number:
OPT0170



Maximum weight

Article number:
OPT0172



Preparation charging station T2500/T3500

Article number:
OPT0352



Programmer for Italsea

Article number:
D0003

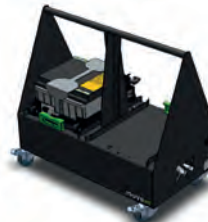

Charging station incl. 1 battery pack

Inclusive one battery pack 24V 75Ah, meant for T2500/T3500

Article number:
OPT0071



U-Frame for waste container 1000/1100L

Article number:
OPT0088

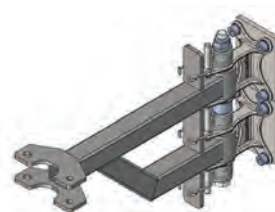

Base part heavy hook 90° lowered

Article number:
H7070

Options T2500-SCOOTER

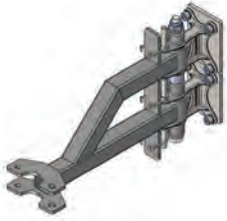

Base part heavy hook 90° raised

Article number:
H7080



Base part hook 90° manual control

Article number:
H7090

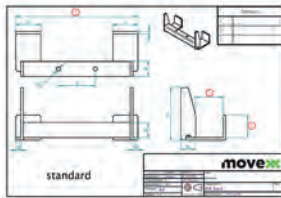

Customized Hook

Please complete corresponding sheet (!)

Article number:
HA5000

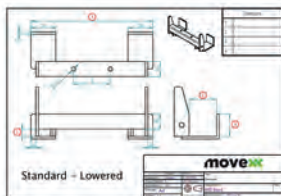

Customized Hook (LOWE-RED)

Please complete corresponding sheet (!)

Article number:
HB5000

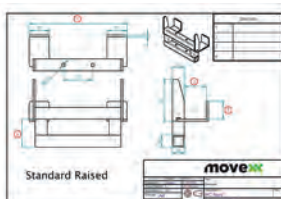

Customized Hook (RAI-SED)

Please complete corresponding sheet (!)

Article number:
HC5000

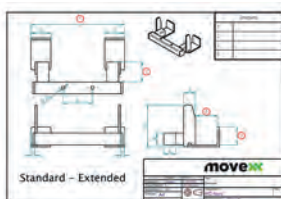

Customized Hook (EX-TENDED)

Please complete corresponding sheet

Article number:
HD5000

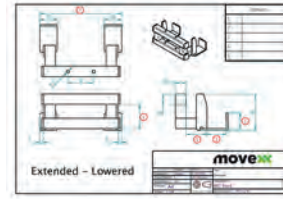

Customized Hook (EX-TENDED / LOWERED)

Please complete corresponding sheet

Article number:
HE5000

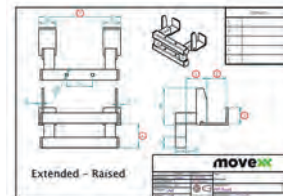

Customized Hook (EX-TENDED / RAISED)

Please complete corresponding sheet

Article number:
HF5000

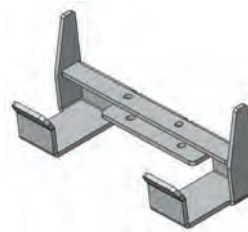

HA245.55.45.15.0

Fronthook for 50mm. Profile, Heavy Duty Hook

Article number:
H0004



Pen for Drawbar Ø16 incl. Backplate

Article number:
H0064



hitch ball coupling Ø 50mm incl. adapter

Article number:
H0068



Towbar for Movexx E-Frame

Suitable for OPT0067

Article number:
H0070

Options T2500-SCOOTER



Towbar + pin Ø15mm incl.
Back plate

Article number:
H0071



Pen for Drawbar Ø10 incl.
Backplate

Article number:
H0072



Hook for LKE Platformwa-
gon Type X

Article number:
H0076

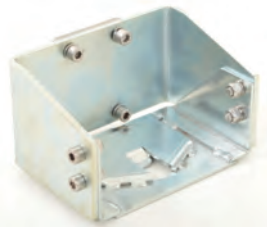

Hook K-Hartwall dolly
DOS1617/1636 90°

Article number:
H0083

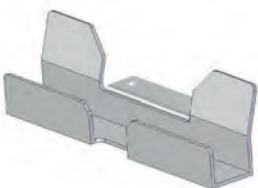

HA250.35.30.0.0

*Hook for 30 mm. Profile For
furniture trolley*

Article number:
H0097



Folding Hook, diameter 16

Article number:
H0128-D16



Folding Hook, diameter 20

Article number:
H0128-D20



Folding Hook, diameter 25

Article number:
H0128-D25



Folding Hook, diameter 27

Article number:
H0128-D27



Folding Hook, diameter 32

Article number:
H0128-D32



Folding Hook, diameter 35

Article number:
H0128-D35

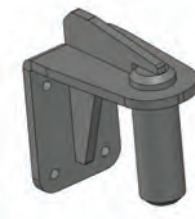

Pin drawbar Ø35 com-
plete

Article number:
H0144

Options T2500-SCOOTER



Folding hook for flower trolleys

Article number:
OPT0099



Electrical locking module for hook

Article number:
OPT0129



Heavy Duty Liftmodule

Article number:
OPT0271



Movexx Parking label

Article number:
OPT0245

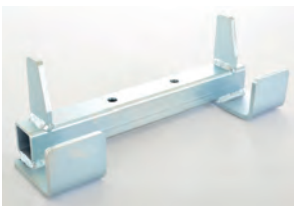

HA270.43.40.0.0

Fronthook for 40mm. profile. Hartwall Pallet-Trolley (DOS1870)

Article number:
H0003



HA250.43.35.0.0

Front hook 40mm. profile

Article number:
H0051



HD370.73.35.0.40

Fronthook for 70mm. profile (Flower container)

Article number:
H0055



HA245.142.35.0.0

Fronthook for 140mm. profile (wooden trolley)

Article number:
H0057



Trailer coupling with frame pen Ø25mm

Article number:
H0062



HA250.23.27.0.0

Fronthook for 20mm. profile

Article number:
H0067



HB245.60.45.30.0

Fronthook for FEIL plastic floor trolley

Article number:
H0092



HA250.28.30.0.0

Fronthook for 25mm. profile

Article number:
H0094

Options T2500-SCOOTER

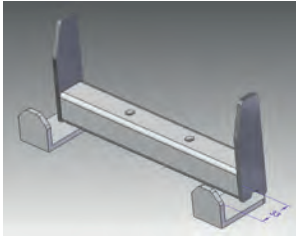

HA250.33.30.0.0

Fronthook for 30mm. profile

Article number:
H0095



HF242.23.30.15.20

*Fronthook for 20 mm. profile
(Hospital Logistics)*

Article number:
H0116



Spring hitch 16 mm

Pin 16 mm.

Article number:
H0120

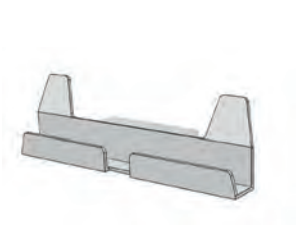

HA250.23.20.0.0

Hook for 20 mm. profile

Article number:
H0123



HB135.18.20.35.0

*Fronthook for 15mm. profiel
(Hartwall Dolly 400x600)*

Article number:
H0125



Coupling nettingscontai-
ner,

Nettings 6mm

Article number:
K0007



Coupling rollcontainer

Nettings 10mm.

Article number:
K0008



Coupling Rollcontainer

Width 42 mm.

Article number:
K0010



Coupling with carabiners

Article number:
K0026

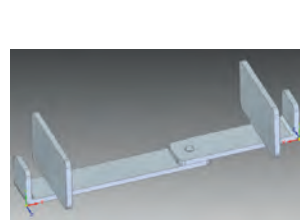

Coupling jaw 20mm

Article number:
K0027



Coupling trolleys side R28

Article number:
K0028



Coupling Open Front-Clo-
sed Backside

Article number:
K0030

Options T2500-SCOOTER

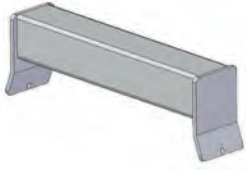

Welding part for trolley's

Profile 50x50mm.

Article number:
OPT0032



Bolt-on part for Trolley's

Profile 50x50mm.

Article number:
OPT0033



Angle limitation

Stainless steel

Article number:
OPT0244

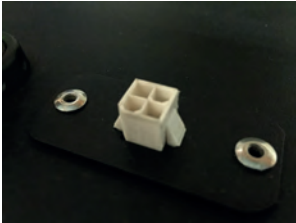

Diagnostic connector

Article number:
OPT0270



Frontcontrol T2500 /
T3500

Article number:
OPT0380



LED lights front and rear
(1)

Article number:
OPT0393



LED lights front and rear
(2)

Article number:
OPT0397



Movexx International B.V.

Generatorstraat 17

3903 LH Veenendaal

Tel +31 (0)318 51.99.00

Fax +31 (0)318 50.80.20

E-mail info@movexx.nl