

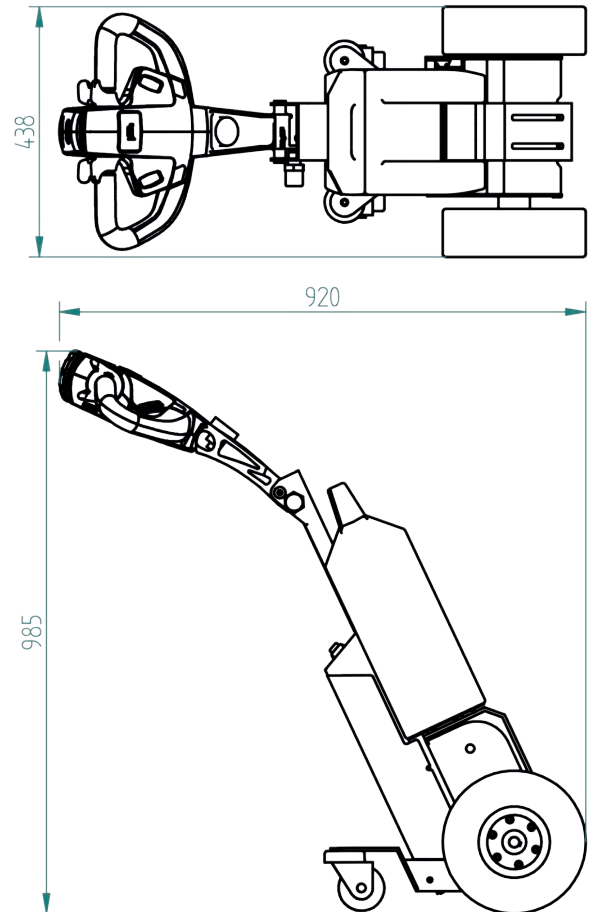

Specifications T1000 RVS

Frame	Stainless steel, glass pearl blasted
Drive	24V DC, 300W, 100 rpm
Weight	43 kg (incl. battery)
Weight trailer	Max. 1000 kg
Battery	Exchangable batterypack
Speed	Max. 5 km/h, freely programmable
Drive wheels	Non marking full rubber ø250x80 mm
Width	438mm
Length	920mm
Adze height	750-985mm (variable)
Folded	831mm
Noise level	63,8 dB
To use from	-40 °C / 70 °C
Protection class	Machine IP44

Dimensions T1000 RVS



Pulling power T1000 RVS (in kg)

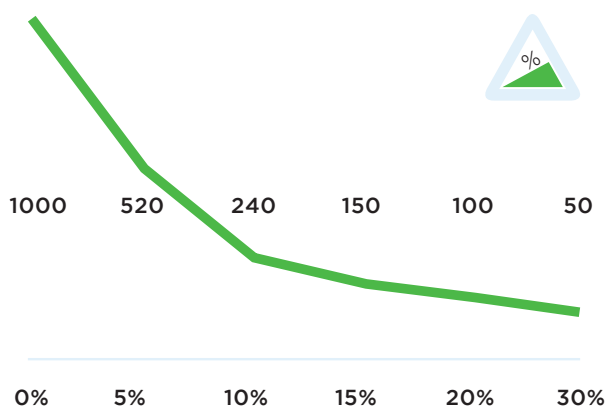

**Measured with a trolley with 2 swivelwheels and 2 fixed castors.
Wheel diameter: 160mm*

Standard T1000 RVS



Standard parts T1000 RVS



Charger 24V 5A incl. charging cable

Item number:
OPT0009



Batterie AGM 22Ah

Item number:
OPT0110



Non-marking driving wheel (full-rubber)

Item number:
M0249



Adjustable tillerhead

Item number:
Standardpart 1

Standard parts T1000 RVS

Motor T1000, without brake



Item number:
M1032

LED battery indicator LBF318-24V



Item number:
M0123

Safety switch



Item number:
Standardpart 2

2 programmable speeds



Item number:
Standardpart 3

Options T1000 RVS



Extra plug to recharge the battery

for on-machine batterie charging

Article number:
OPT0001



Battery Lithium-LiFePO4,
36Ah GREEN

Article number:
OPT0106



Battery upgrade to Lithium-LiFePO4, 36Ah

iso AGM Battery (!) Including upgrade to lithium charger 10A

Article number:
OPT0107



Batterie AGM 22Ah

Article number:
OPT0110



Electromagnetic parking-brake T1000

Article number:
OPT0004



Emergency stop complete

Article number:
OPT0063



Acoustic signal driving backwards

Article number:
OPT0254



Flashlight tube tiller head support (st)

Article number:
OPT0415



Radio remote control

6 channel

Article number:
OPT0026-2



Counterweight T1000 front 30kg stainless

Counterweight T1000 front 30kg, stainless steel

Article number:
OPT0035



Document holder with clip

Article number:
OPT0053



hour counter complete

Article number:
OPT0056

Options T1000 RVS

Antistatic strip



Article number:
OPT0058

Code lock



Article number:
OPT0068

Preparation electric hook



Article number:
OPT0143

Ignition key unequal key



Article number:
OPT0145

Ignition key equal key 701



Article number:
OPT0146

Customized programming



please indicate specific settings

Article number:
OPT0170

Horn for sleeve drawbar support (stainle)

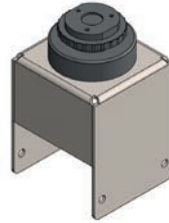

Article number:
OPT0414

Programmer for Italsea



Article number:
D0003

Wall mounted Charger, for AGM battery



Complete charger-unit Including AGM battery charger (5 Ah)

Article number:
OPT0015

Stainless Charger For 1 AGM battery



Article number:
OPT0015-RVS

Charging Station for 1 Lithium battery



Wallmounting chargerstation with lithium battery charger 29,2 V, 10 A

Article number:
OPT0023

Charging station for 5 Lithium batteries



Article number:
OPT0029

Options T1000 RVS



Charging station for 5 batteries

Upright standing charging station with five separate AGM battery chargers 24 V, 5 A

Article number:
OPT0039



Stainless charger for 5 batteries

Article number:
OPT0039-RVS



Upgrade to charging station

Article number:
OPT0261

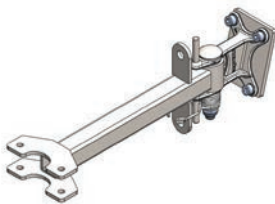

Base part hook 15° Stainless steel

Article number:
H7011



Hook locking system

Article number:
OPT0012



Lifting module for Hooks stainless steel

Article number:
OPT0050-RVS



Electrical locking module for hook

Article number:
OPT0129



Movexx Parking label

Article number:
OPT0245



HA245.55.45.0.0 (RVS)

Article number:
H0004 CLEAN RM

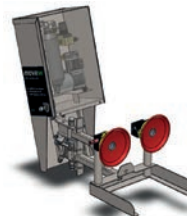

Vacuum hook for stainless steel trolleys

Article number:
H0093

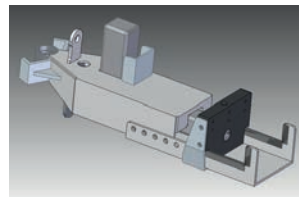

Clamping Hook Stainless steel

Article number:
H0096



Coupling nettingscontainer,

Nettings 6mm

Article number:
K0007

Options T1000 RVS

Coupling rollcontainer



Nettings 10mm.

Article number:
K0008

Coupling Rollcontainer



Width 42 mm.

Article number:
K0010

Coupling Rollcontainer



Suitable for rack Ø6 mm. (Deli XL)

Article number:
K0012

Coupling for Norm trolleys

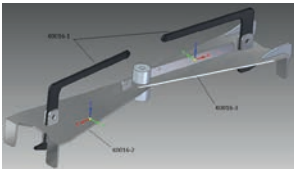

Article number:
K0016

Angle limitation hook 15 degrees



Article number:
OPT0218

Diagnostic connector

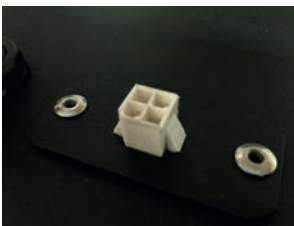

Article number:
OPT0270

Charging station replacement battery wit



Article number:
OPT0339



Movexx International B.V.

Generatorstraat 17

3903 LH Veenendaal

Tel +31 (0)318 51.99.00

Fax +31 (0)318 50.80.20

E-mail info@movexx.nl